



**STEP** Collection



FULL BODY VITRIFIED TILES

# STAY TRENDY

with  
the new collection of full body vitrified  
steps and risers

---

# STEPS THAT SOUND SAFETY

## Introducing

---

Stairs and staircases are defined by more than just their usefulness. These functional devices are also appealing from a style standpoint, since well-appointed staircases are now a distinguishing element in homes, rooms, or halls. Marfil full body Steps and risers are available in a variety of colours and shades to complement your interior and external areas.

## Size

**300X  
1200mm**

A P R I C O T



Size  
**300x1200mm**

Surface  
**Polished | Matt**

Thickness  
**09mm**



**BULL NOSE  
MOULDING**



**SANDWICH**



**GROOVE WITH  
EPOXY FILLING**

**STEP** Collection

A stair riser is the near-vertical element in a set of stairs, forming the space between one step and the next. It is sometimes slightly inclined from the vertical so that its top is closer than its base to the person climbing the stairs.

# A P R I C O T

---



APRICOT

300x1200mm





A P R I C O T

# B U T T E R



Size  
**300x1200mm**

Surface  
**Polished | Matt**

Thickness  
**09mm**



**BULL NOSE  
MOULDING**



**SANDWICH**



**GROOVE WITH  
EPOXY FILLING**

**STEP** Collection

A stair riser is the near-vertical element in a set of stairs, forming the space between one step and the next. It is sometimes slightly inclined from the vertical so that its top is closer than its base to the person climbing the stairs.

# B U T T E R

---



BUTTER

300x1200mm





B U T T E R

# CHARCOAL BLACK

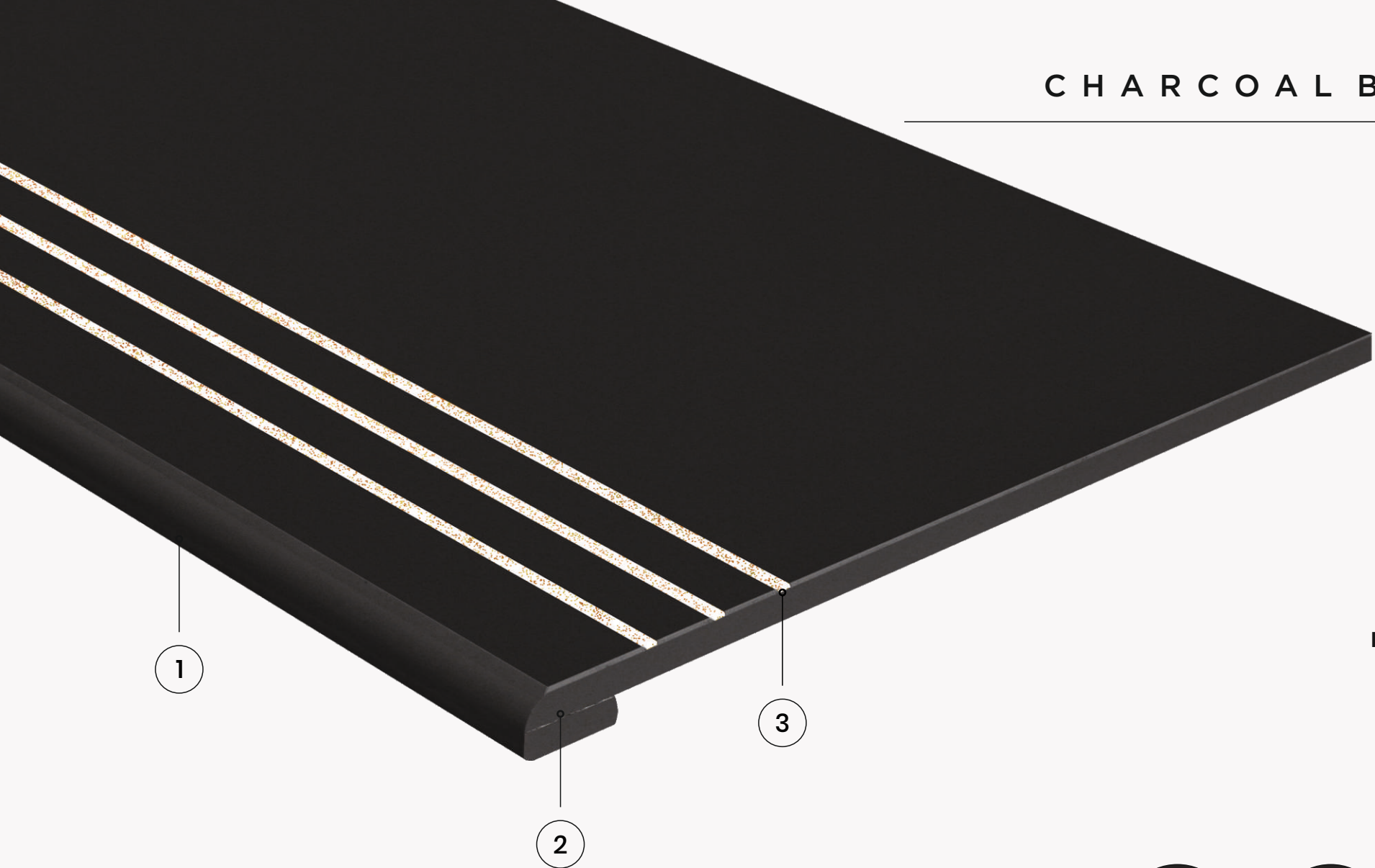

Size  
**300x1200mm**

Surface  
**Polished | Matt**

Thickness  
**09mm**



A stair riser is the near-vertical element in a set of stairs, forming the space between one step and the next. It is sometimes slightly inclined from the vertical so that its top is closer than its base to the person climbing the stairs.



**BULL NOSE  
MOULDING**



**SANDWICH**



**GROOVE WITH  
EPOXY FILLING**

# C H A R C O A L B L A C K

---

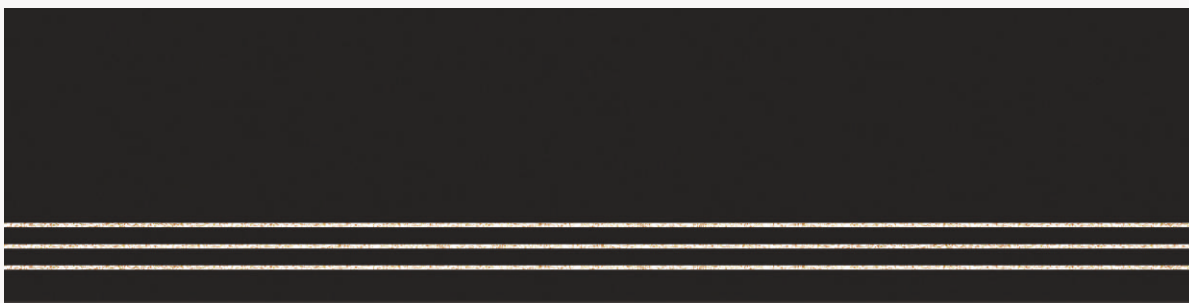

CHARCOAL BLACK

300x1200mm





C H A R C O A L B L A C K

# D O L O M I N E

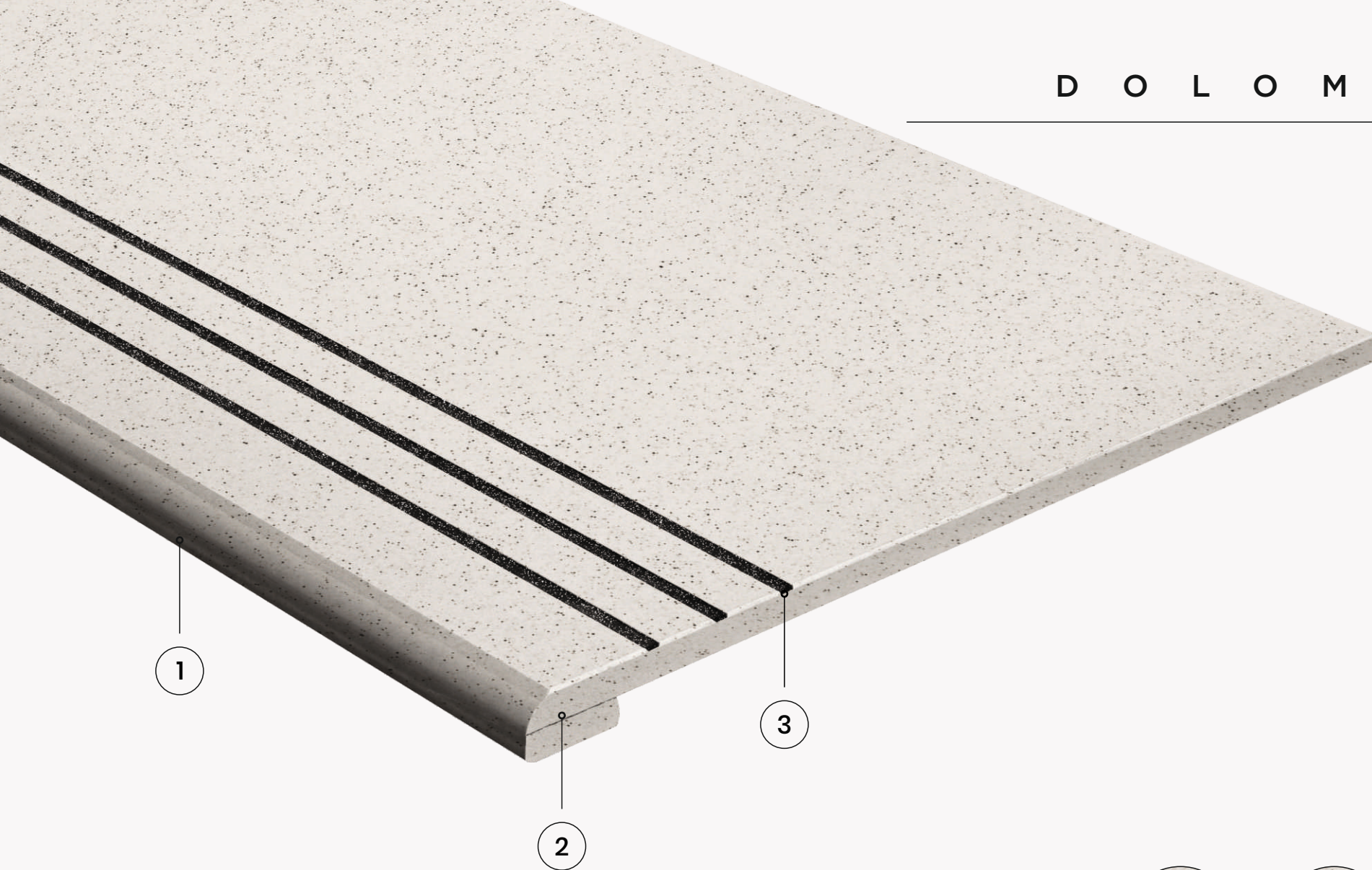

Size  
**300x1200mm**

Surface  
**Polished | Matt**

Thickness  
**09mm**

**STEP** Collection

A stair riser is the near-vertical element in a set of stairs, forming the space between one step and the next. It is sometimes slightly inclined from the vertical so that its top is closer than its base to the person climbing the stairs.



**BULL NOSE  
MOULDING**



**SANDWICH**



**GROOVE WITH  
EPOXY FILLING**

# D O L O M I N E

---

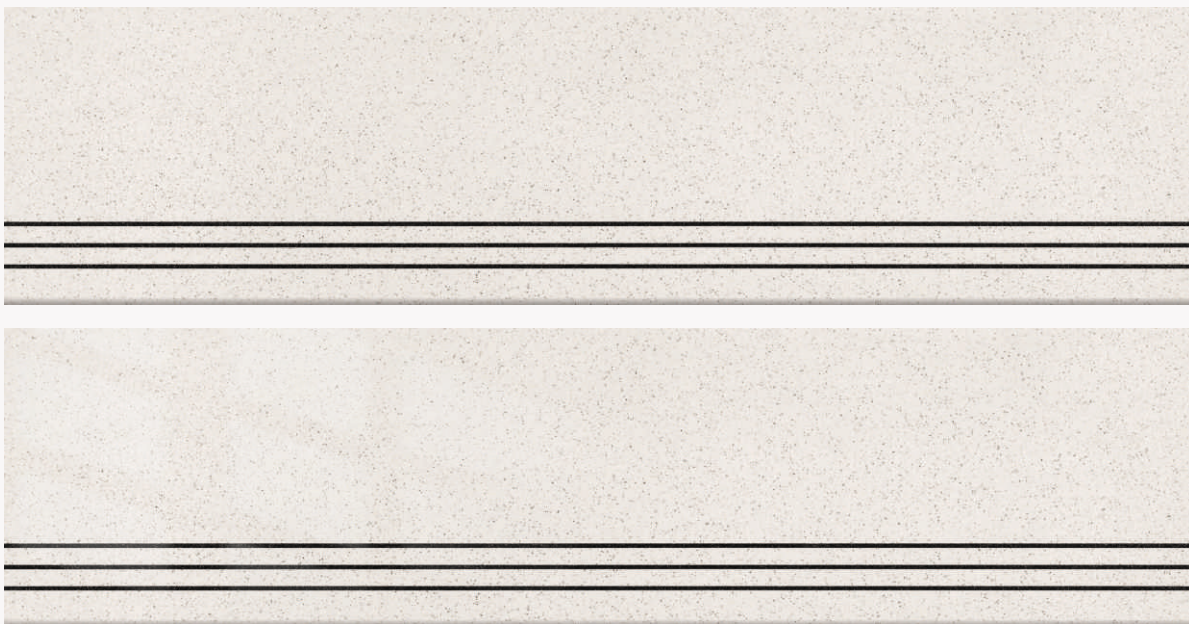

DOLOMINE

300x1200mm





D O L O M I N E

# D O L P H I N

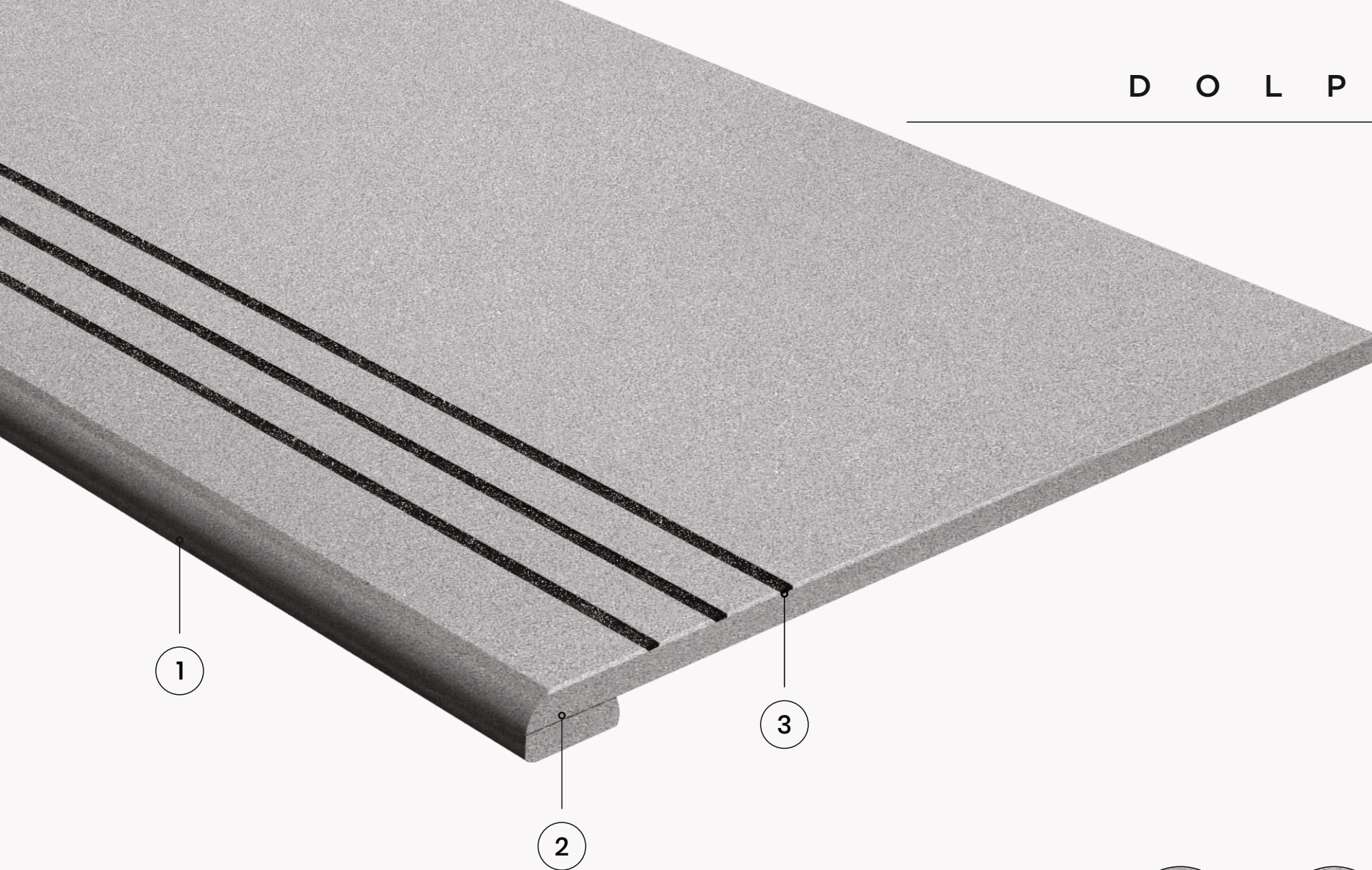

Size  
**300x1200mm**

Surface  
**Polished | Matt**

Thickness  
**09mm**

**STEP** Collection

A stair riser is the near-vertical element in a set of stairs, forming the space between one step and the next. It is sometimes slightly inclined from the vertical so that its top is closer than its base to the person climbing the stairs.

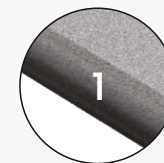

**1**  
BULL NOSE  
MOULDING



**2**  
SANDWICH



**3**  
GROOVE WITH  
EPOXY FILLING

# D O L P H I N

---

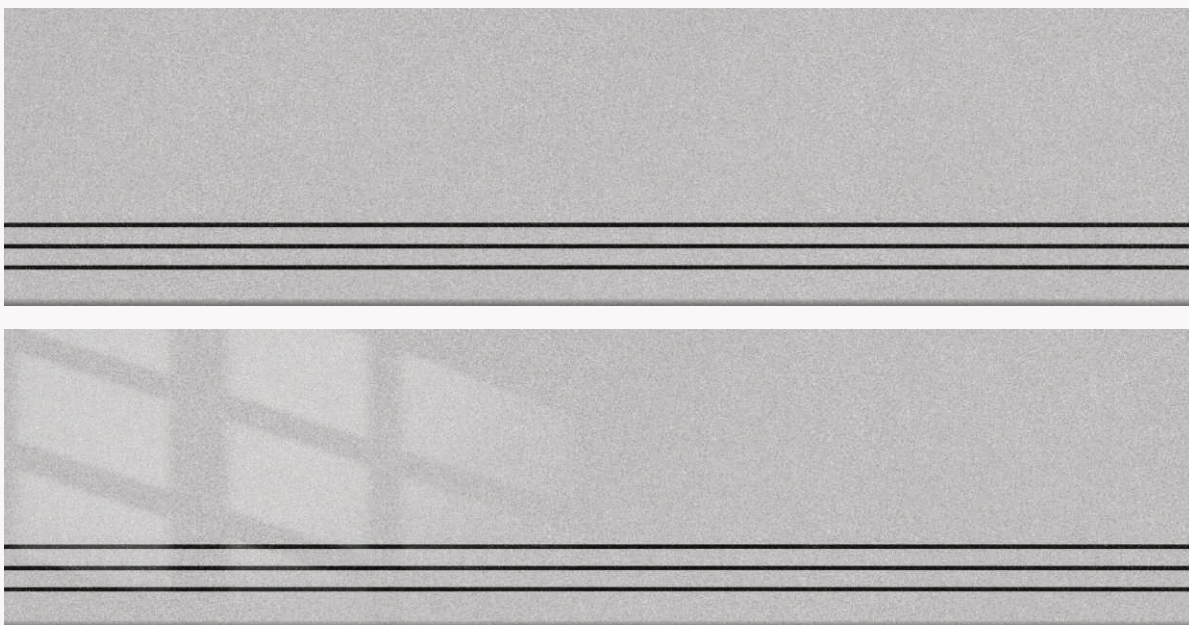

DOLPHIN

300x1200mm





D O L P H I N

# F O R E S T

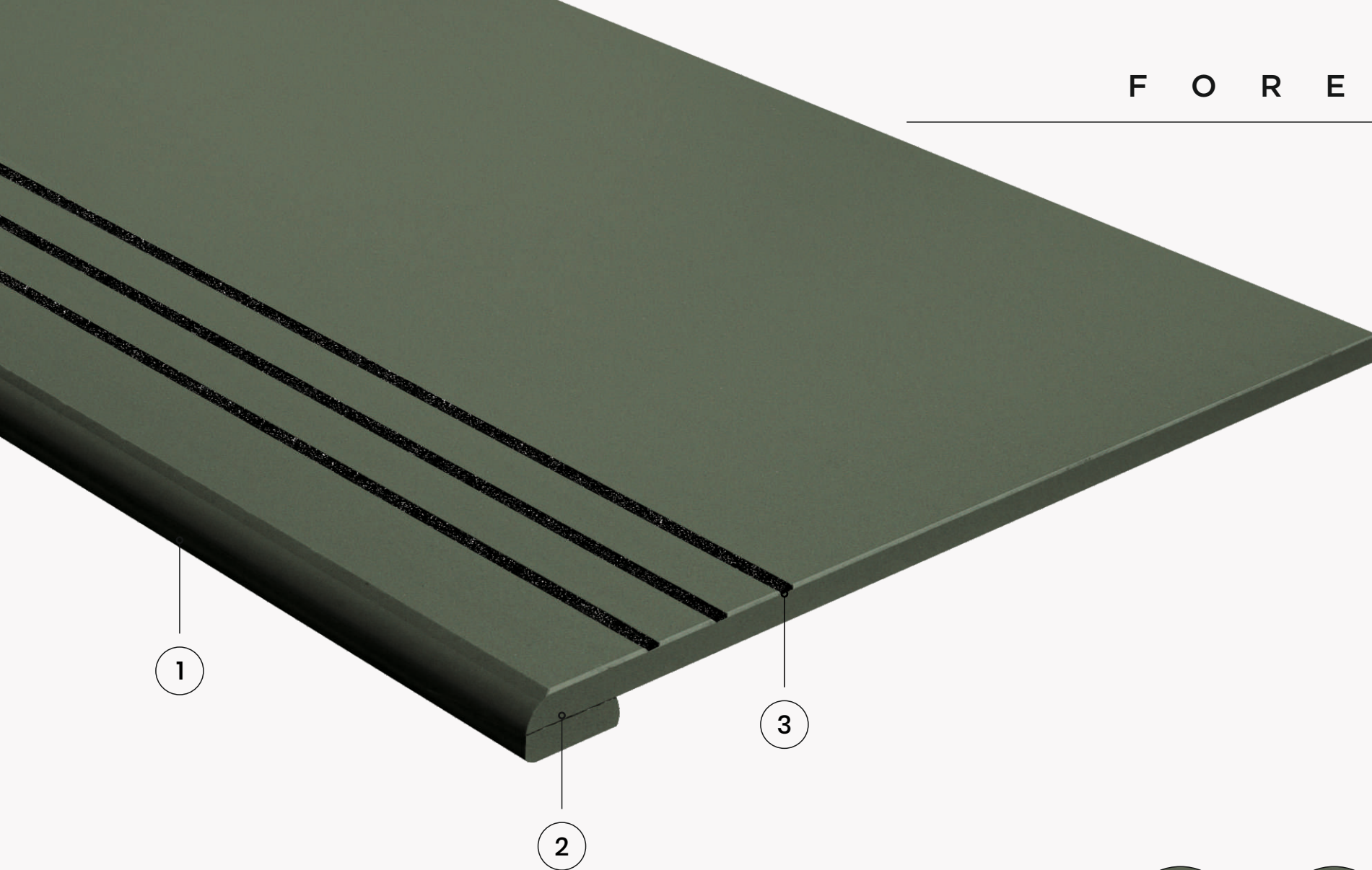

Size  
**300x1200mm**

Surface  
**Polished | Matt**

Thickness  
**09mm**



**1**  
BULL NOSE  
MOULDING



**2**  
SANDWICH



**3**  
GROOVE WITH  
EPOXY FILLING

**STEP** Collection

A stair riser is the near-vertical element in a set of stairs, forming the space between one step and the next. It is sometimes slightly inclined from the vertical so that its top is closer than its base to the person climbing the stairs.

# F O R E S T

---

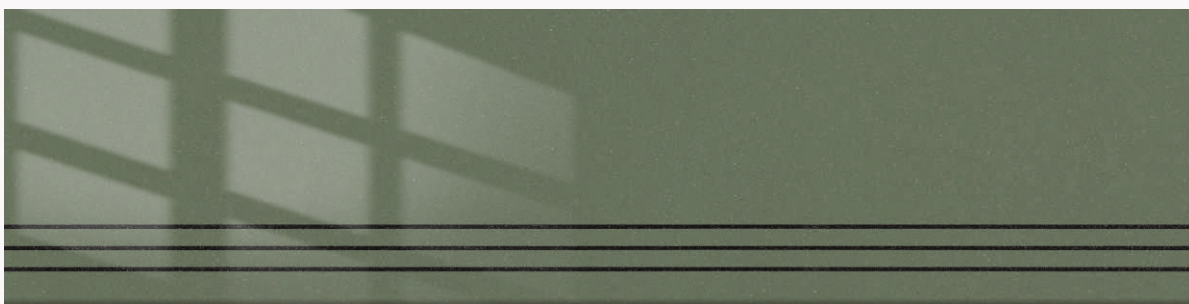
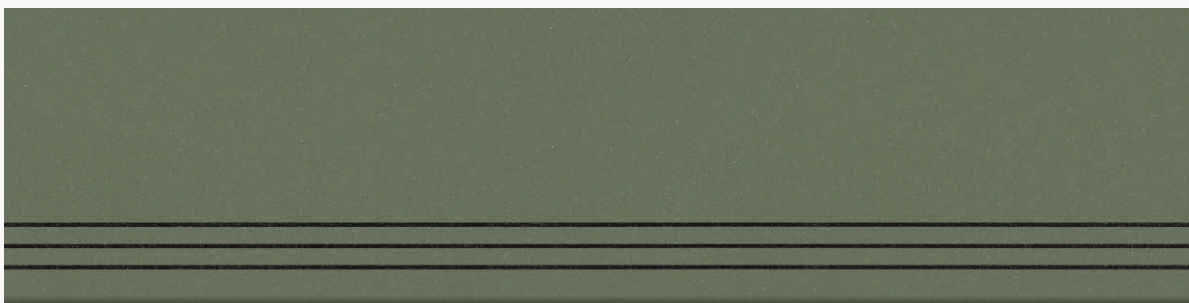

FOREST

300x1200mm



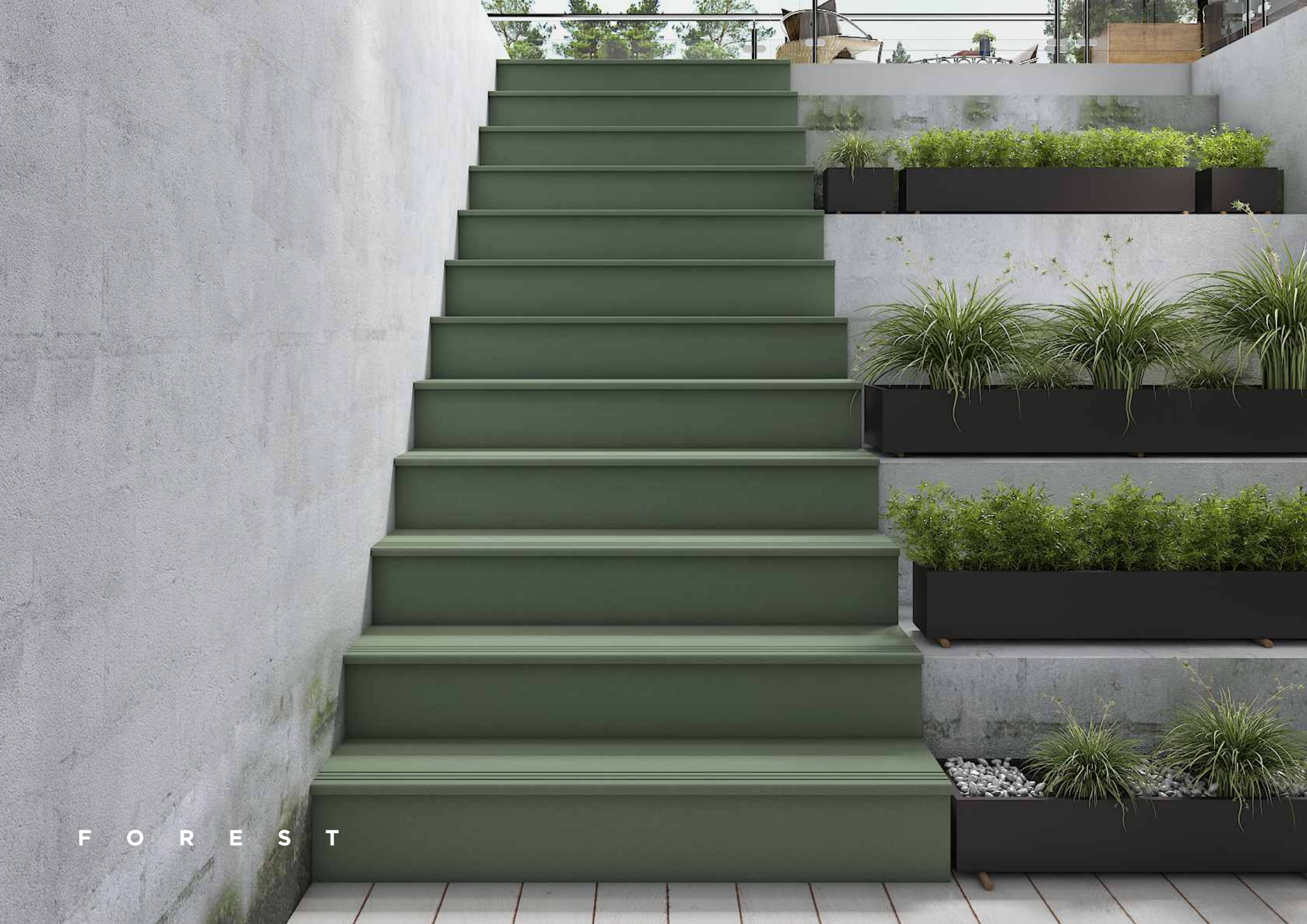

F O R E S T

# GRAPHITE



Size  
**300x1200mm**

Surface  
**Polished | Matt**

Thickness  
**09mm**

1

2

3



**BULL NOSE  
MOULDING**



**SANDWICH**



**GROOVE WITH  
EPOXY FILLING**

**STEP** Collection

A stair riser is the near-vertical element in a set of stairs, forming the space between one step and the next. It is sometimes slightly inclined from the vertical so that its top is closer than its base to the person climbing the stairs.



G R A P H I T E

# G R A P H I T E

---

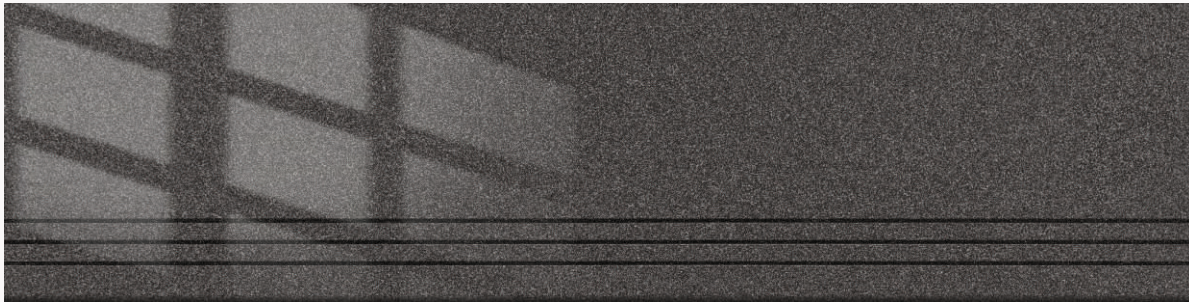

GRAPHITE

300x1200mm

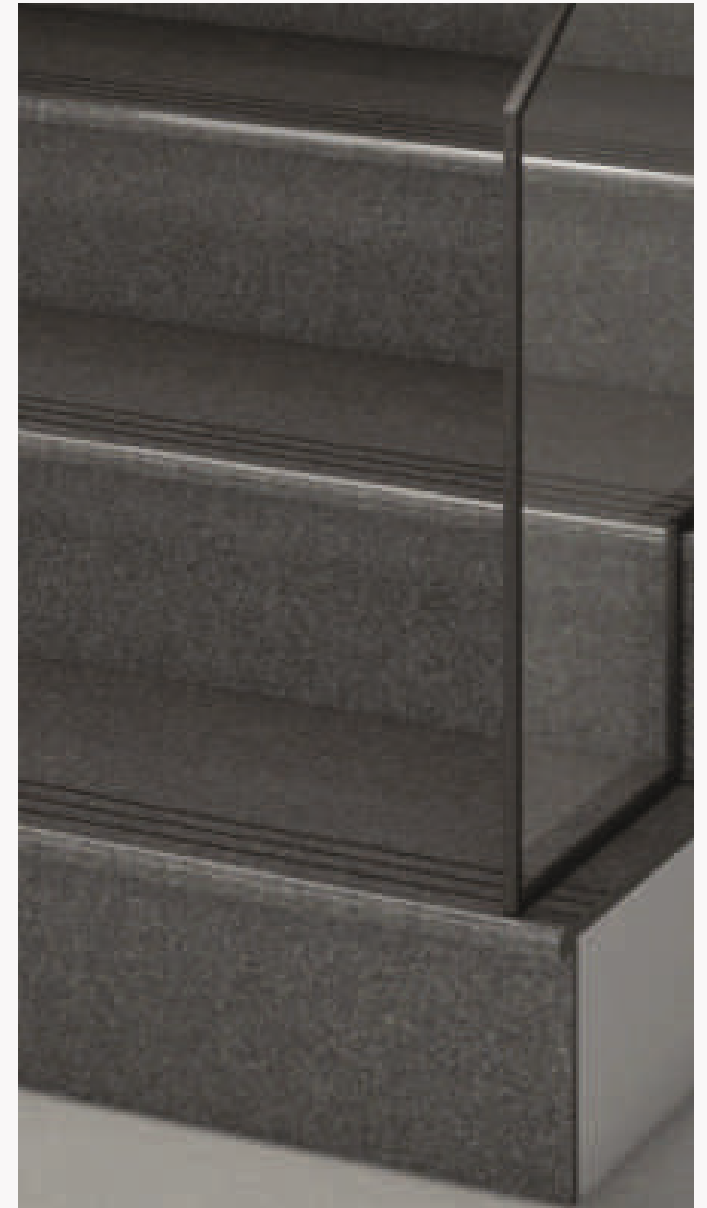

# M U S H R O O M

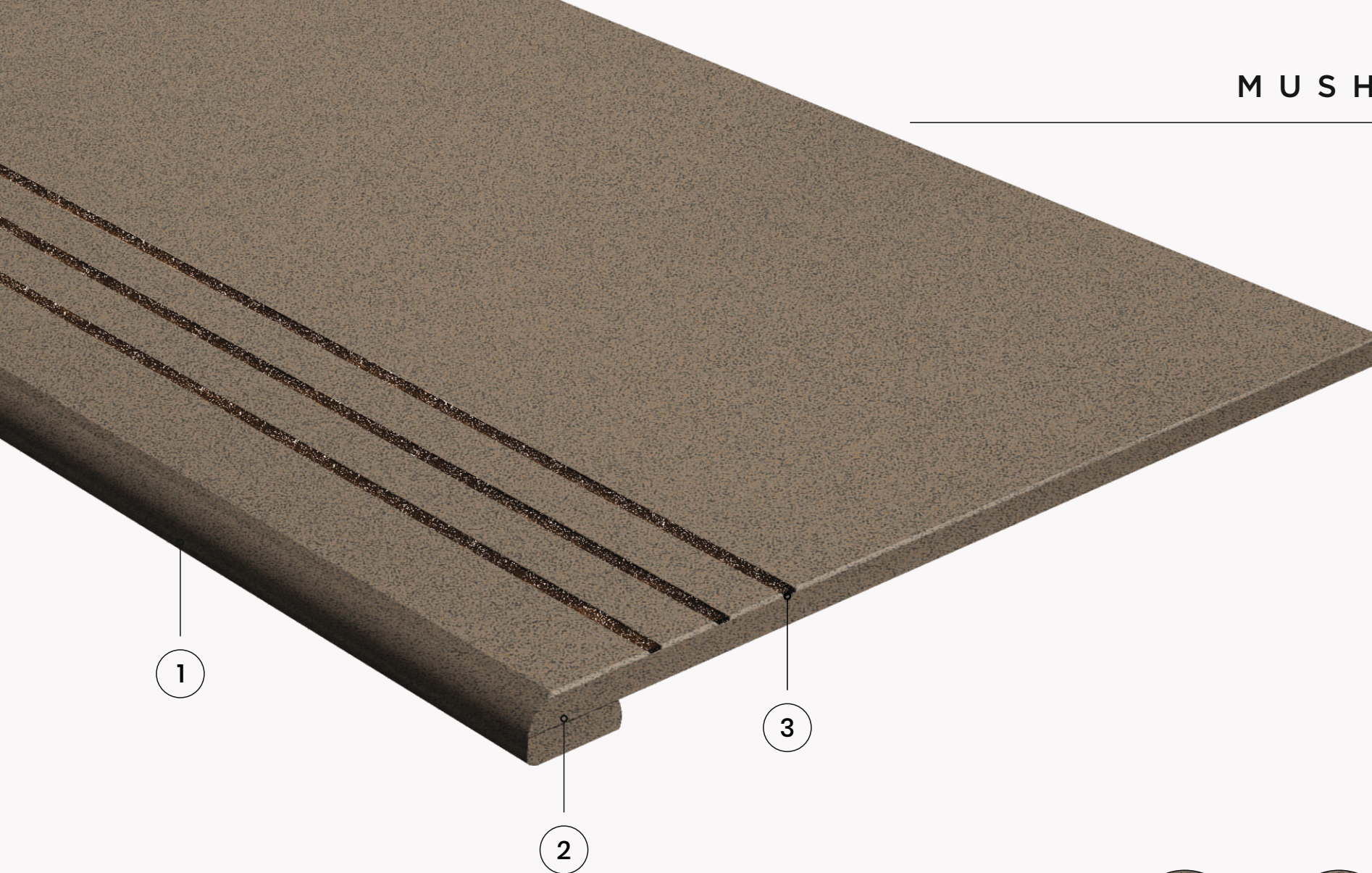

Size  
**300x1200mm**

Surface  
**Polished | Matt**

Thickness  
**09mm**



**BULL NOSE  
MOULDING**



**SANDWICH**



**GROOVE WITH  
EPOXY FILLING**

**STEP** Collection

A stair riser is the near-vertical element in a set of stairs, forming the space between one step and the next. It is sometimes slightly inclined from the vertical so that its top is closer than its base to the person climbing the stairs.

# M U S H R O O M

---

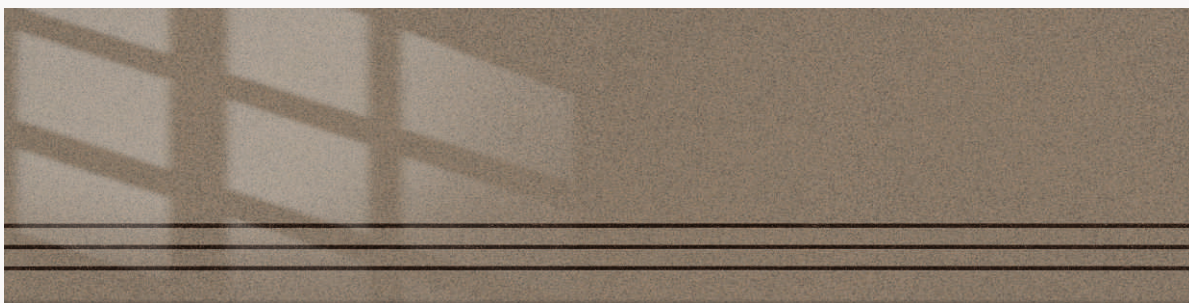
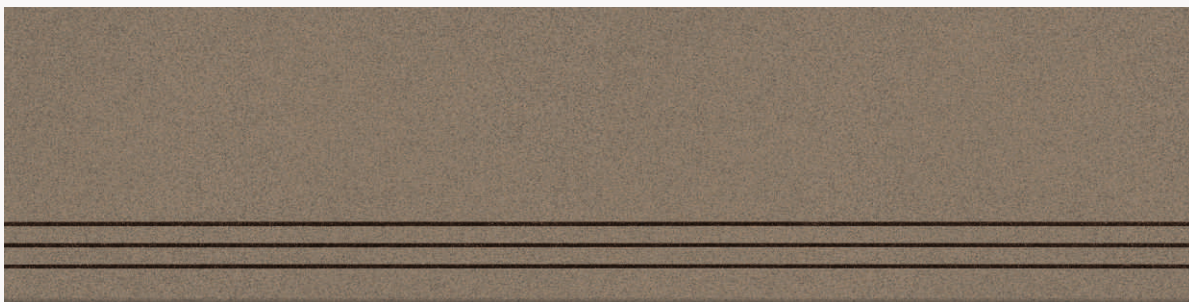

MUSHROOM

300x1200mm





M U S H R O O M

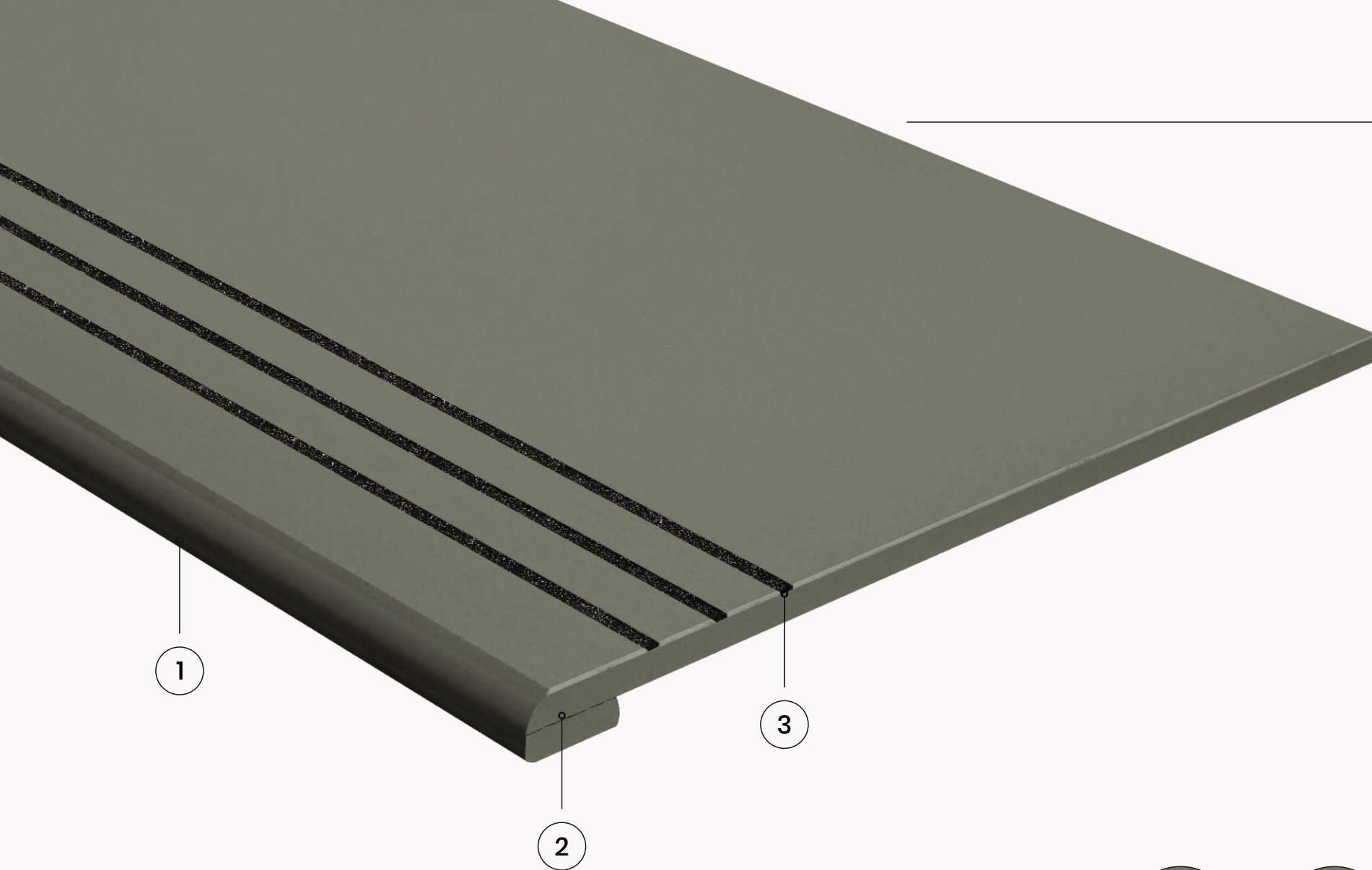

Size  
**300x1200mm**

Surface  
**Polished | Matt**

Thickness  
**09mm**



**BULL NOSE  
MOULDING**



**SANDWICH**



**GROOVE WITH  
EPOXY FILLING**

**STEP** Collection

A stair riser is the near-vertical element in a set of stairs, forming the space between one step and the next. It is sometimes slightly inclined from the vertical so that its top is closer than its base to the person climbing the stairs.

# O L I V E

---

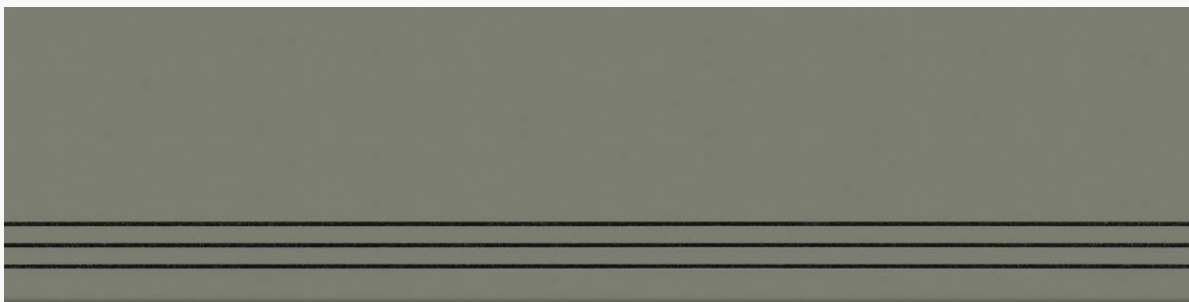

OLIVE

300x1200mm



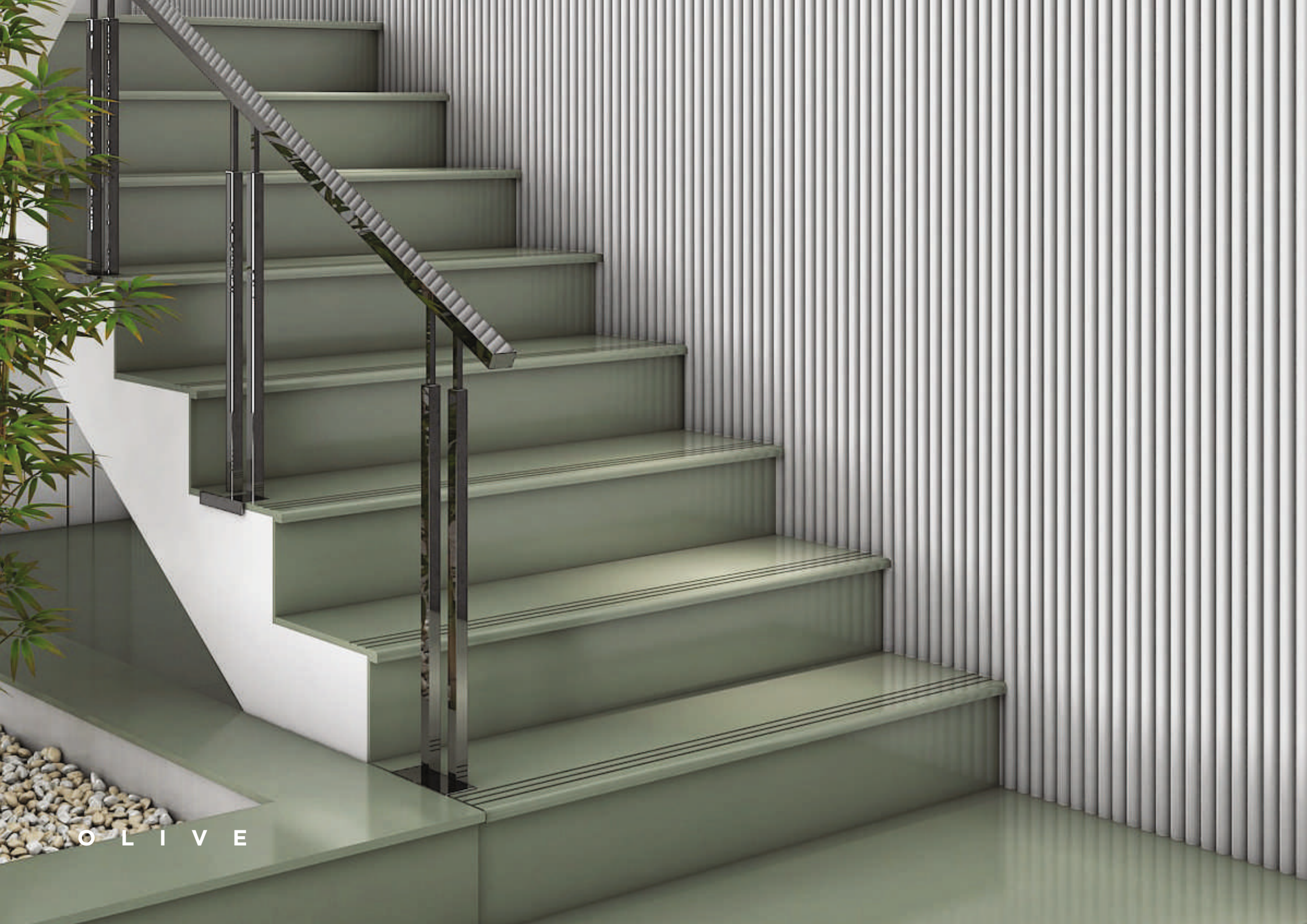

O L I V E

# SNOW WHITE

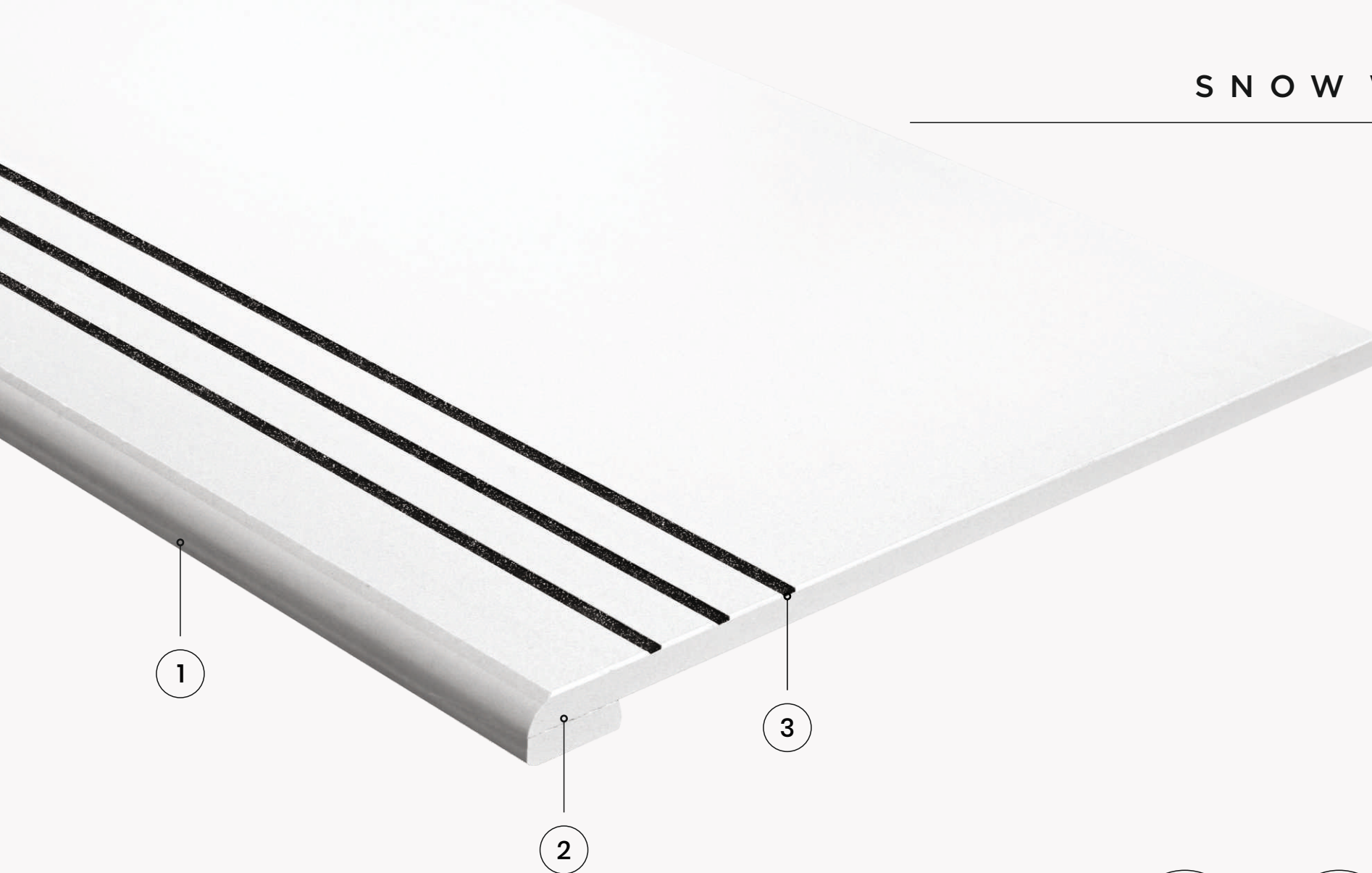

Size  
**300x1200mm**

Surface  
**Polished | Matt**

Thickness  
**09mm**



**BULL NOSE  
MOULDING**



**SANDWICH**



**GROOVE WITH  
EPOXY FILLING**

**STEP** Collection

A stair riser is the near-vertical element in a set of stairs, forming the space between one step and the next. It is sometimes slightly inclined from the vertical so that its top is closer than its base to the person climbing the stairs.

# S N O W W H I T E

---

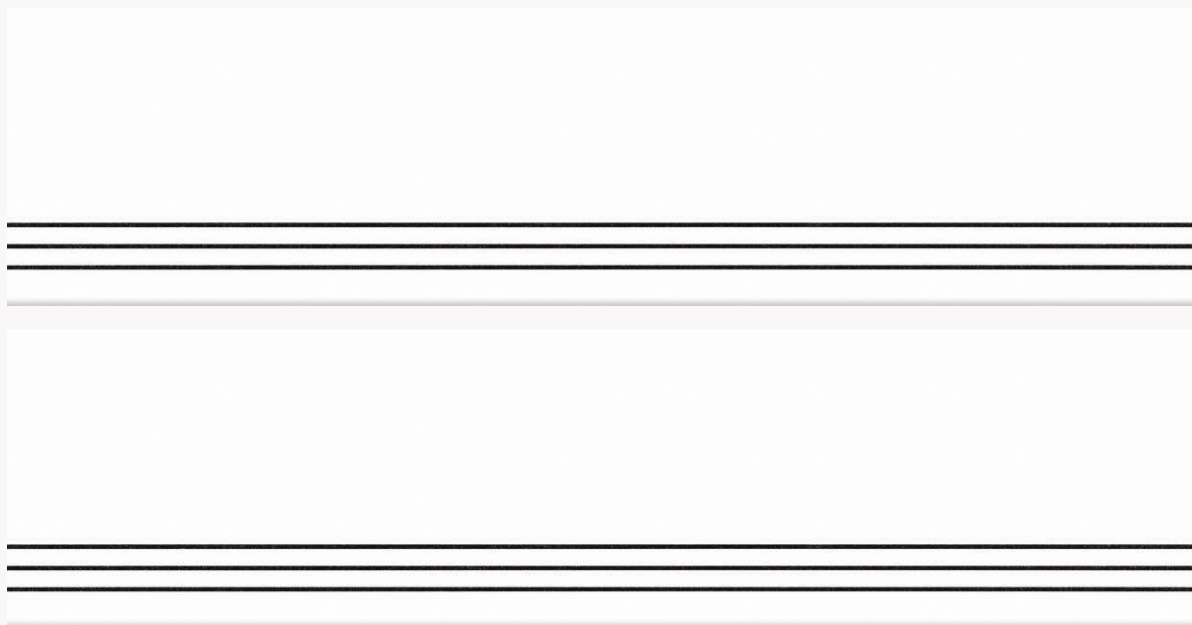

SNOW WHITE

300x1200mm





S N O W W H I T E

# STEEL GREY

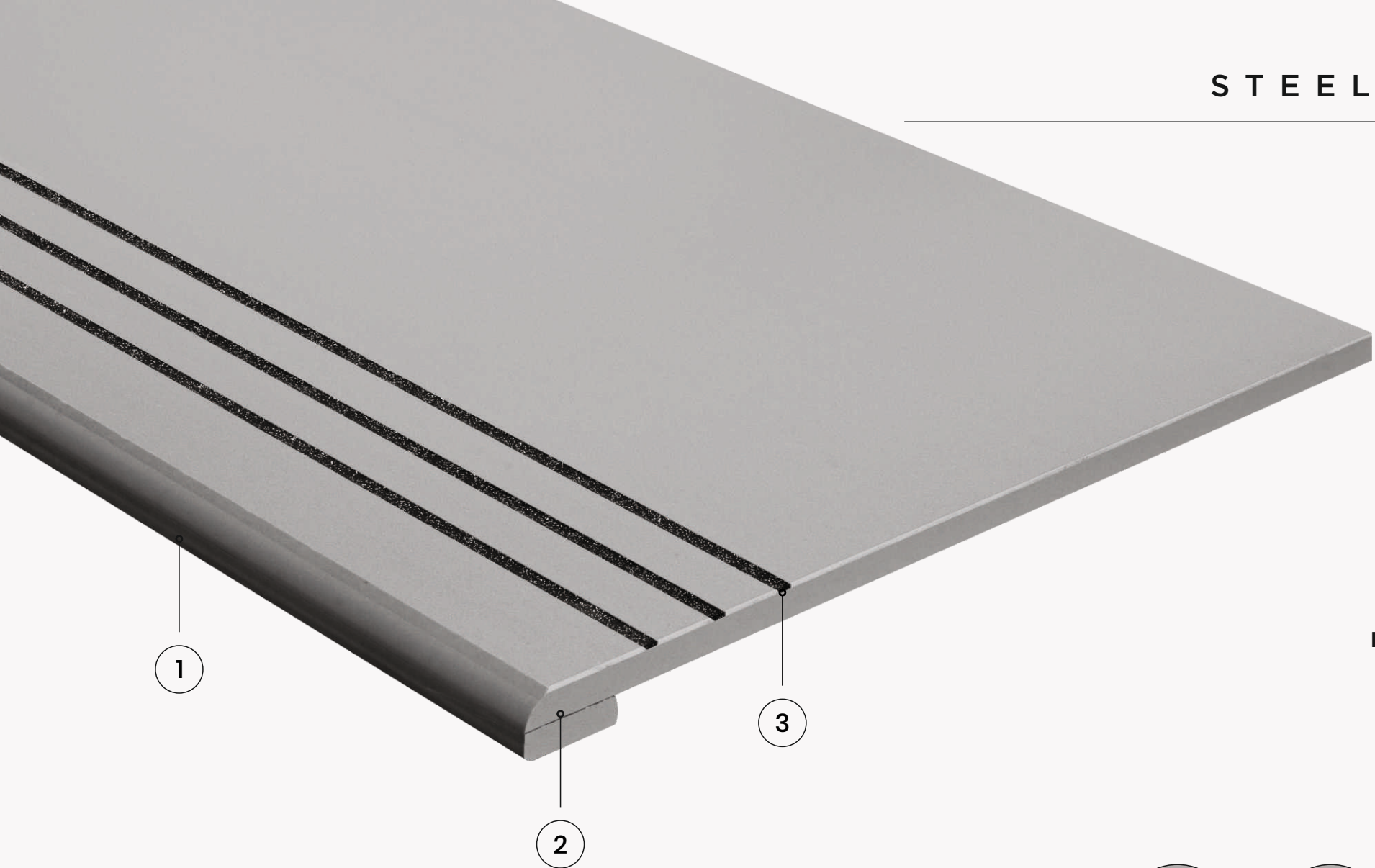

Size  
**300x1200mm**

Surface  
**Polished | Matt**

Thickness  
**09mm**



A stair riser is the near-vertical element in a set of stairs, forming the space between one step and the next. It is sometimes slightly inclined from the vertical so that its top is closer than its base to the person climbing the stairs.



**BULL NOSE  
MOULDING**



**SANDWICH**



**GROOVE WITH  
EPOXY FILLING**

# S T E E L G R E Y

---

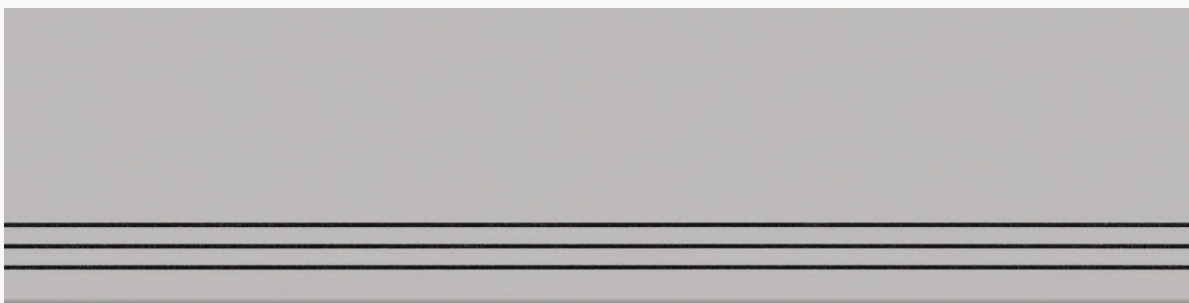

STEEL GREY

300x1200mm





S T E E L G R E Y

# SLATE GREY

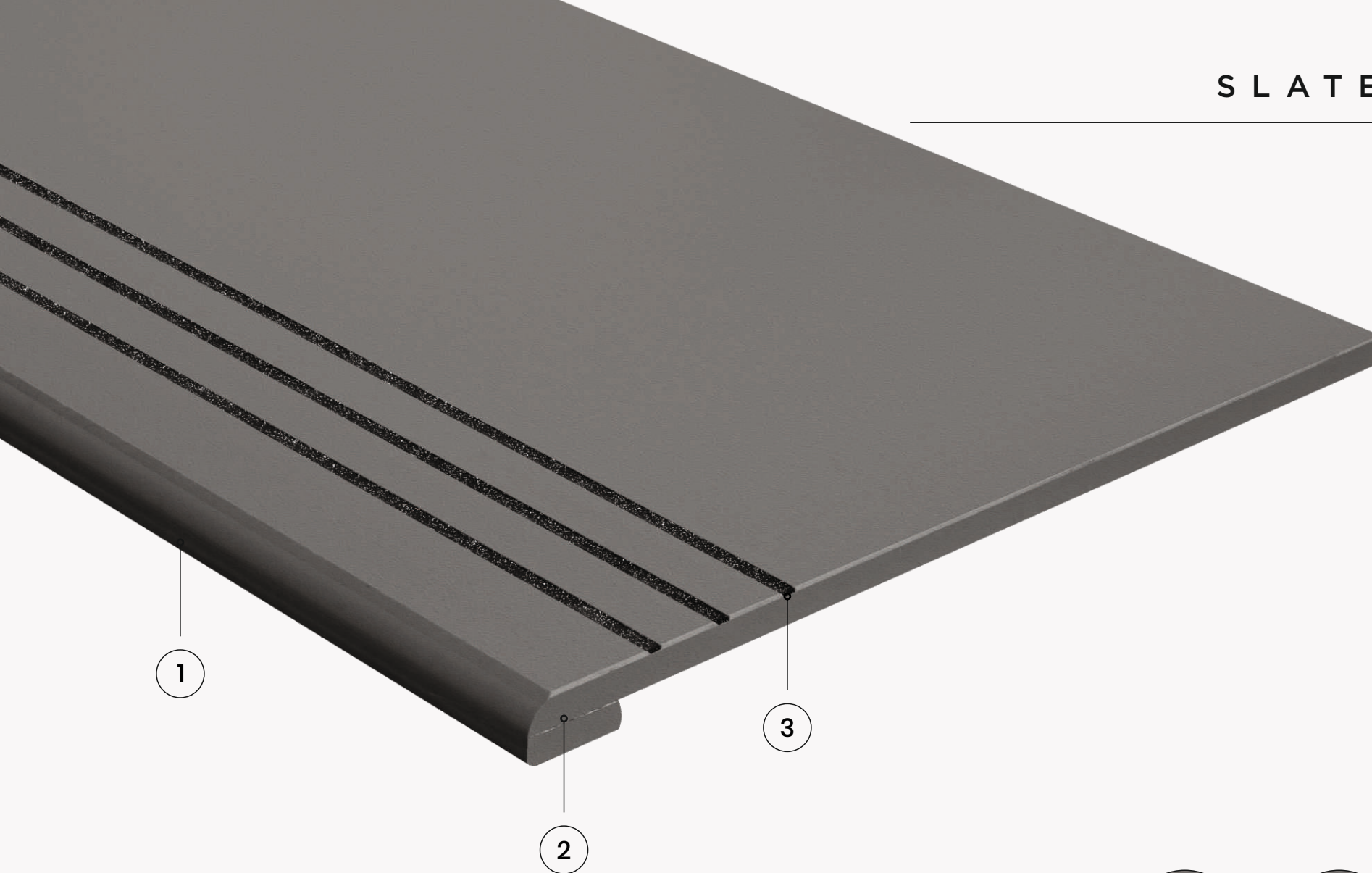

Size  
**300x1200mm**

Surface  
**Matt**

Thickness  
**09mm**

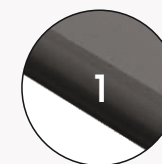

**BULL NOSE  
MOULDING**



**SANDWICH**

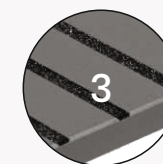

**GROOVE WITH  
EPOXY FILLING**

**STEP** Collection

A stair riser is the near-vertical element in a set of stairs, forming the space between one step and the next. It is sometimes slightly inclined from the vertical so that its top is closer than its base to the person climbing the stairs.

# S L A T E G R E Y

---



SLATE GREY

300x1200mm





S L A T E G R E Y

# S M O K E

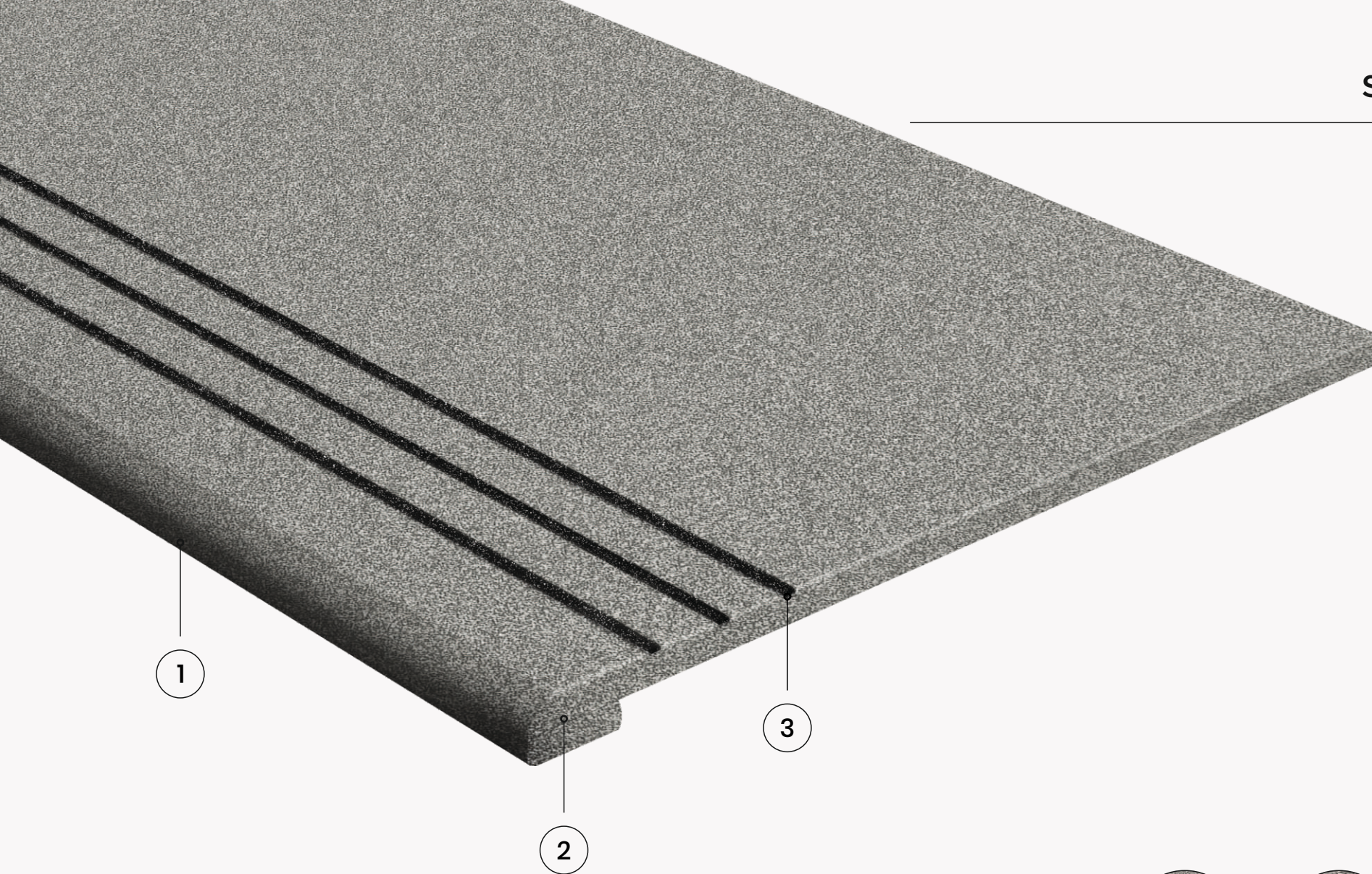

Size  
**300x1200mm**

Surface  
**Matt**

Thickness  
**09mm**

**STEP** Collection

A stair riser is the near-vertical element in a set of stairs, forming the space between one step and the next. It is sometimes slightly inclined from the vertical so that its top is closer than its base to the person climbing the stairs.

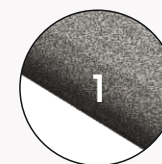

**BULL NOSE  
MOULDING**



**SANDWICH**

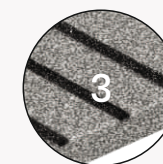

**GROOVE WITH  
EPOXY FILLING**

# S M O K E

---

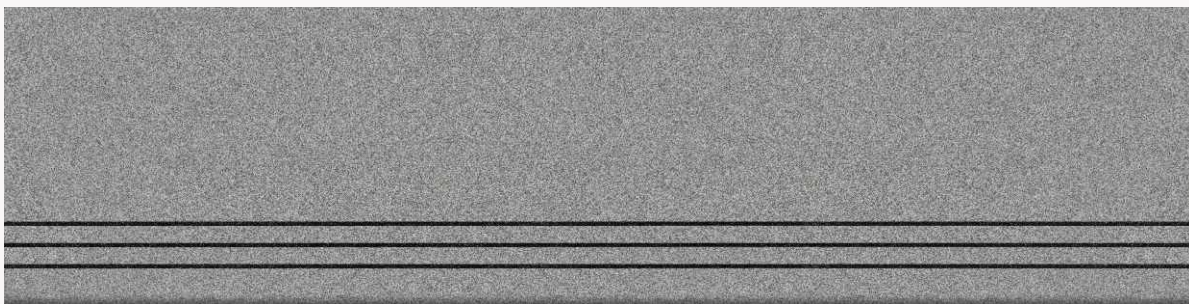

SMOKE

300x1200mm





S M O K E

# TERRAIN

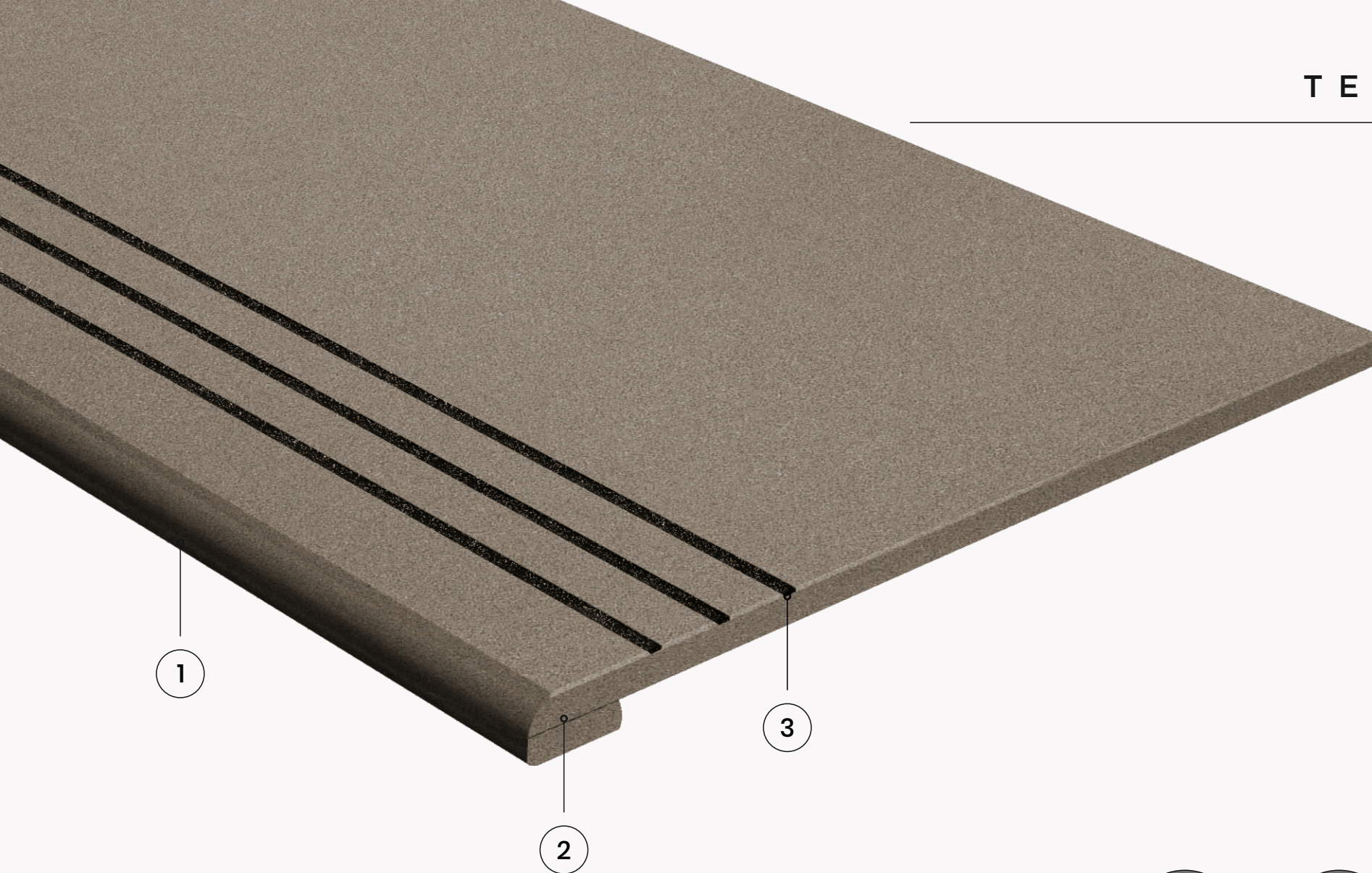

Size  
**300x1200mm**

Surface  
**Matt**

Thickness  
**09mm**

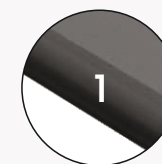

**BULL NOSE  
MOULDING**



**SANDWICH**



**GROOVE WITH  
EPOXY FILLING**

**STEP** Collection

A stair riser is the near-vertical element in a set of stairs, forming the space between one step and the next. It is sometimes slightly inclined from the vertical so that its top is closer than its base to the person climbing the stairs.

# TERRAIN

---

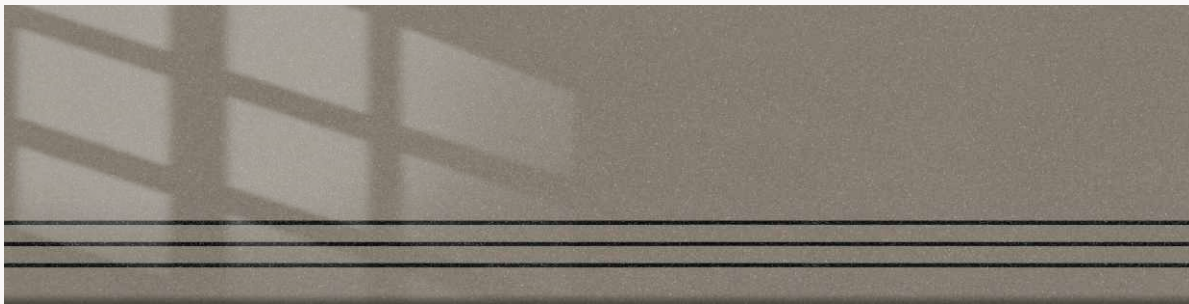
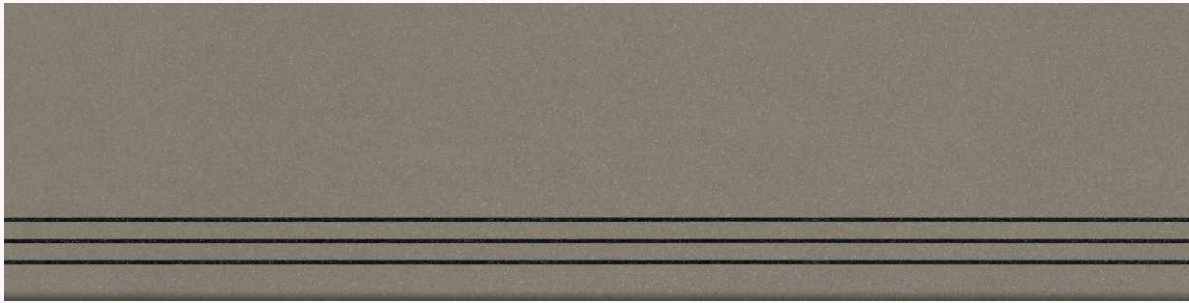

TERRAIN

300x1200mm

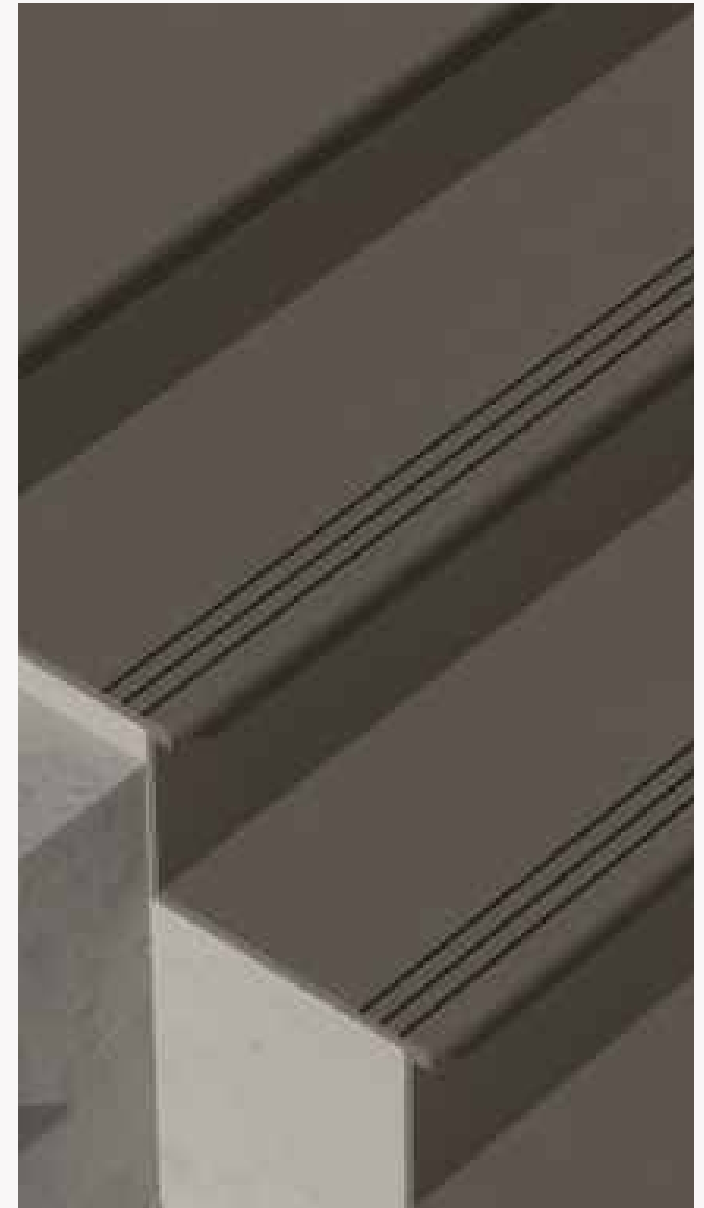



T E R R A I N

